

specter

SPECTER STANDARD MODULES
SNOOT PENDANT 50

bold
lighting



SNOOT PENDANT 50

Our Magnetic track system, SPECTER, is a highly configurable, 2 circuits, 24VDC low voltage track system. Thanks to its magnet mounting technology, the modules are inter-changeable instantaneously. Our track is available in ceiling pendant, surface and recessed mounting for both ceiling and walls. SPECTER track is also available with an optional linear upright feature. The snoot pendant module complements the SPECTER range with a minimalistic pendant cylinder equipped with a wide range of optics and optical accessories allowing professional lighting.

- Up to 1055lm delivered output
- Various optical accessories available such as beam shaping lenses and Honeycomb louvers
- Beam options, narrow, medium, flood and wide
- Fixtures designed to mount in SPECTER track
- Available in 4 standard finishes: Black, white, silver and bronze

Notes: ¹ Available dimming 0-10V and DALI

Code example: **SPSF-P**20W-W-N827-2

STANDARD FINISHES

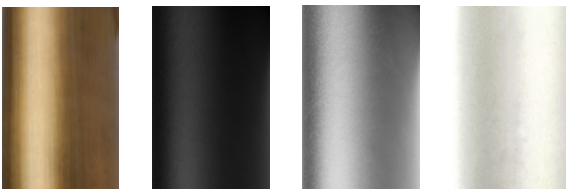

Z

B

S

W

DELIVERED LUMEN OUTPUT

Length	Watts	CRI +80				CRI +90			
		2700K	3000K	3500K	4000K	2700K	3000K	3500K	4000K
2"	10W	785lm	872lm	959lm	1055lm	633lm	703lm	773lm	851lm

Series	Length		Body Finish		Baffle Finish		Beam Angle		CRI		Color Temp		Circuit	
SPSF-P	20	2"	W	White	W	White	N	12°	8	+80	27	2700K	1	1-Circuit
			B	Black	B	Black	M	24°	9	+90	30	3000K	2	2-Circuit
			S	Silver	S	Silver	F	36°			35	3500K		
			Z	Bronze	Z	Bronze	H	50°			40	4000K		
			X	Custom	X	Custom								



Bold Lighting
4710 Ecton Dr., Marietta, GA 30066, USA
info@boldlighting.us www.boldlighting.us
t: +1-678-903-4061

Photometric data:
Type C Polar Curves

SNOOT PENDANT 50

12° Beam Angle

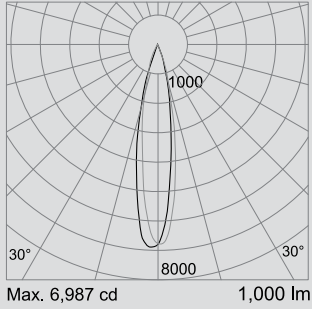

24° Beam Angle

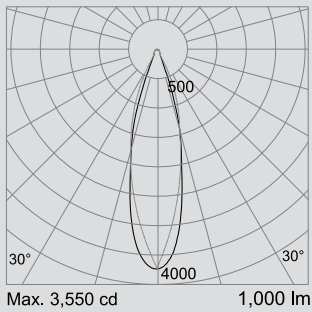

36° Beam Angle

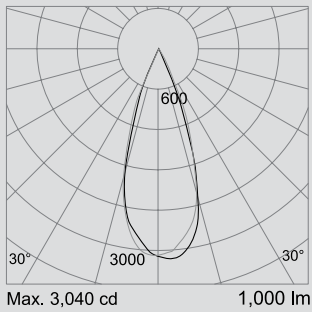

50° Beam Angle

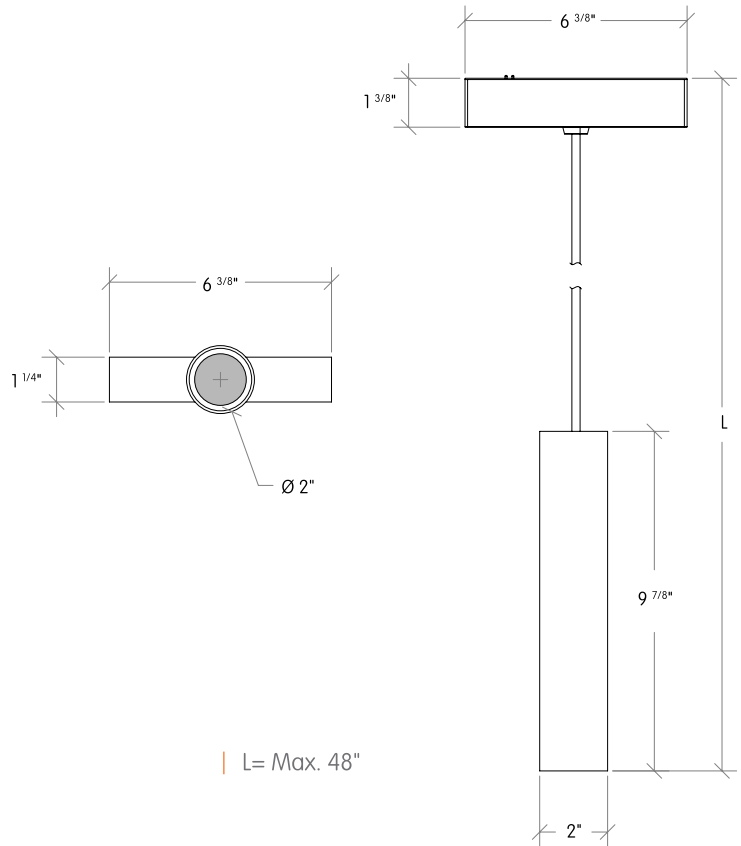
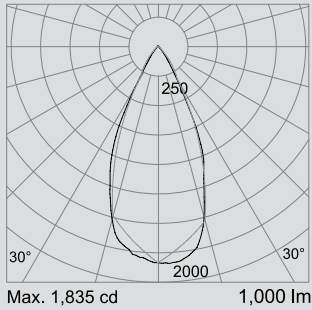

OPTICAL ACCESSORIES

Lenses and anti-glare devices

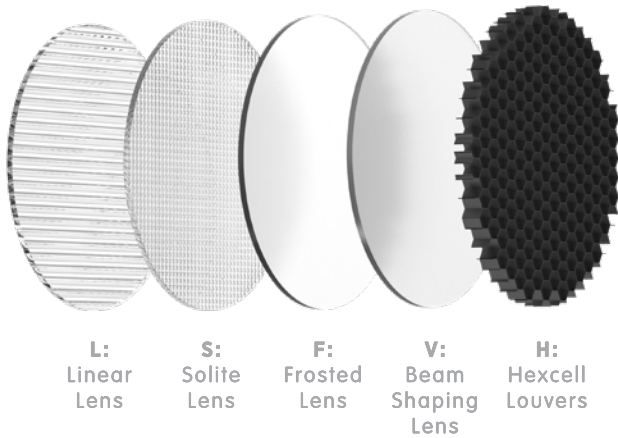

Fits model # / Size		Beam		Finish	
Snoot Pendant 50	Diameter 2"	S	Solite	—	None
		L	Linear	BL	Flat Black
		F	Frosted	SL	Silver
		V	Beam Shaping	WH	White
		H	Hexcell Louvers		

Beam Shaping lenses Options

	No Filter Beam Shaping Filter	C-HE10	C-HE15	C-HE20	C-HE30	C-HE40	C-HE55	C-HE80
FWHM Beam Angle	15°	18°	21°	25°	35°	46°	65°	80°

Special Beam Shapes	No Filter Beam Shaping Filter	Elliptical 6010	Elliptical 6030	Direction Turning 8°	Direction Turning 20°	C-HE40	C-HE55	C-HE80
FWHM Beam Angle	15°	60° x 10°	60° x 30°	▷ 8°	▷ 20°	46°	65°	80°